



# TRICEL

GENERATIONS OF INNOVATION

## Tricel® Novo UK6-50

### Wastewater Treatment Plants

*Engineering a green future*



# Contents

1	Health & safety precautions .....	3
1.1	General.....	3
1.2	Electrical / maintenance .....	3
1.3	Installation .....	3
2	Introduction: Tricel Novo .....	4
2.1	Treatment stages .....	4
3	Tricel Novo Range .....	5
3.1	Dimensions.....	5
3.2	Tank drawings.....	7
3.3	Pumped Outlet .....	11
3.3.1	Standard pump specification:.....	12
3.3.2	Outlet connection: .....	12
4	Transportation & lifting.....	13
4.1	Lifting tanks of 1-4 modules (Max. 4.6m).....	13
4.2	Lifting tanks of 5-6 modules (Max. 6.6m).....	14
5	Installation .....	15
5.1	Installation planning .....	15
5.2	Inspection upon reception of tanks .....	15
5.3	Positioning and precautions .....	15
5.4	Types of installation .....	16
5.5	Installation procedure .....	17
5.5.1	Excavation (Dry & Wet sites) .....	17
5.5.2	Installation – step by step guide.....	19
5.6	Gravel specification .....	20
5.7	Concrete specification.....	21
5.8	Topsoil requirements.....	21
5.9	Risers .....	22
5.10	Non-standard installations.....	23
5.10.1	Alternative to concrete backfill (for wet sites without risers only).....	23
5.10.2	Sloping ground .....	23
5.10.3	Proximity to rolling & static loads .....	23
5.11	Electrical requirements.....	24
5.11.1	Electrical Diagrams .....	25
5.12	Additional accessories .....	30

5.12.1	Grease trap .....	30
5.12.2	Sampling chamber .....	30
6	Plant operation .....	30
6.1	Diffuser-manifold calibration (only applicable on plants UK12 and larger) .....	31
6.2	Timed sludge-return system (only applicable to plants UK24 and larger) .....	31
7	Disposal of treated water .....	31
8	Maintenance .....	32
8.1	Regular maintenance .....	32
8.2	Annual maintenance .....	32
8.3	Annual service (available from your supplier) .....	32
8.4	Production of sludge .....	33
8.5	De-sludging (emptying the solid waste from the primary chamber) .....	33
9	Operating conditions .....	33
10	Troubleshooting .....	36
10.1	Plant operation .....	36
10.2	Odours .....	38
11	Certification .....	38
11.1	Declaration of performance .....	39
12	Terms & conditions .....	42

**Important**

This manual must be used in conjunction with British Water's 'Flows and Loads' when sizing wastewater treatment plants.

# 1 Health & safety precautions

It is important to read the full technical manual prior to installation. Retain this document for the lifetime of the product and in the event of a change of ownership of the site, transfer to the new owner. As health and safety are of vital importance, the following aspects are critical:

## 1.1 General

- Ensure the adherence to all the information always contained in this manual.
- Treated wastewater is not suitable for human consumption.
- It is important that locks are fitted to the lid to prevent accidental access.
- Manholes are rated to 125kg and are for pedestrian use only.
- Never enter a tank, unless qualified to do so.
- Do not use naked flames in the vicinity of the tank due to the danger of combustion.
- The manhole access covers shall never be left off an unattended tank. Following the completion of any work carried out, always lock the access covers of the plant.
- Sewage and sewage effluent can carry micro-organisms and gases harmful to human health. Any person carrying out work on the plant must be trained appropriately. Suitable protective clothing: including gloves, goggles should be always worn. Always remove contaminated clothing and protective equipment after working with sewage treatment plants. Wash hands and face before eating, drinking, or smoking.
- All manhole access covers must be kept locked for safety reasons. Tanks are supplied with three locking points, as shown below. All locking points should be locked with a suitable locking device to prevent unauthorised access. Locking devices do not come supplied.



## 1.2 Electrical / maintenance

- All electrical work to be carried out by a qualified electrician using suitable materials for the application.
- Do not open the Tricel Novo air-blower housing without first isolating the mains power.
- Electrical work must be carried out strictly to the manufacturer's instructions and comply with the relevant national regulations for electrical installations.
- When working with machinery / electrical equipment, the proximity of water shall be noted. Electrical equipment shall not be wet when working with it.
- There is the potential danger of falling into the tank during de-sludging when utility holes may be open – take all necessary safety precautions when de-sludging.

## 1.3 Installation

- Plan excavation work with due regard to health and safety requirements.
- Excavated material should either be shored or battened back to a "safe" angle.
- Use appropriate lifting equipment.
- Take necessary care around ground-work machinery.
- Keep proper footing and balance at all times.
- **Installations that require 500mm or 750mm risers require a concrete installation. It is not possible to retrofit 500mm & 750mm risers to tanks with gravel installations.**

## 2 Introduction: Tricel Novo

Tricel Novo wastewater treatment plants are manufactured from Sheet Moulding Compound (SMC) ensuring a durable and strong product. SMC is a fiberglass-based compression moulded material used in applications that require high strength and durability. Lightweight and compact design facilitate ease of installation for domestic and light commercial applications up to 50 PE.

The Tricel Novo gets manufactured in modular components; the individual modules are fabricated together to make various sized tanks.

### 2.1 Treatment stages

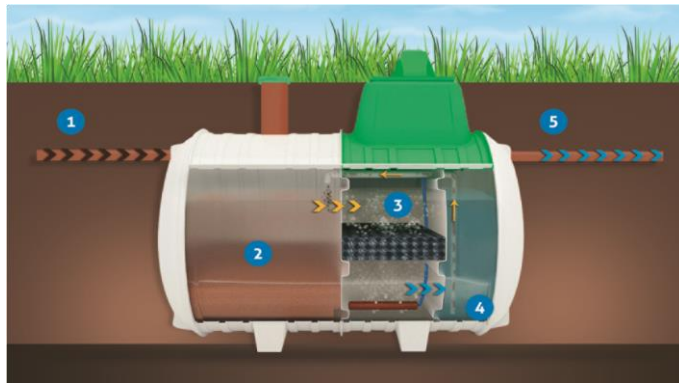

1. Wastewater from the dwelling, toilets, sinks, shower and further domestic sources enter the plant.
2. The effluent enters the primary settlement chamber. Settlement occurs when the heavier solids drop out of the wastewater and settle to the bottom of the tank to create sludge, and the lighter solids float to the top of the water to create scum. The top layer acts as a seal and stops odours escaping. This chamber separates up to 70% of the solids present.
3. Next is the aeration chamber, where masses of naturally occurring bacteria inhabit specially designed plastic filter media. The bacteria feed on the waste removing it from the liquid. A continuous supply of air from the low-pressure, high-volume compressor in the top section of the unit sustains these bacteria. Wastewater passes through the filter media repeatedly, ensuring a very high treatment efficiency.
4. The wastewater then proceeds to the final settlement chamber. Any remaining minute bacterial particles separate from the wastewater within this chamber before discharge from the plant. This process slows the liquid's velocity, allowing for any final trace impurities to settle to the bottom of the tank. A sludge return system then returns these impurities to the primary settlement chamber.
5. The remaining treated wastewater now meets the required standard and is safely passed out of the Tricel Novo plant. The treated effluent is now ready for discharge to a suitably designed discharge area as required by the relevant local authority.

# 3 Tricel Novo Range

## 3.1 Dimensions

Tricel Novo wastewater treatment plants: certified to EN 12566-3.

Tricel Novo		UK6 3000L (SR)	UK6 3000L	UK6 4000L	UK8 (SR)	UK8	UK10	UK12	UK18	UK24	UK30
<b>Max. Population Equivalent</b>	<b>PE</b>	<b>6</b>	<b>6</b>	<b>6</b>	<b>8</b>	<b>8</b>	<b>10</b>	<b>12</b>	<b>18</b>	<b>24</b>	<b>30</b>
Design flow rate (max.)	litres/day	900	900	900	1200	1200	1500	1800	2700	3600	4500
BOD load (max.)	kg/day	0.36	0.36	0.36	0.48	0.48	0.6	0.72	1.08	1.44	1.8
No. of persons		1-6	1-6	1-6	3-8	3-8	4-10	4-12	6-18	8-24	10-30
Primary chamber capacity	litres	1485	1485	2400	1934	1934	2178	2400	2552	4183	3733
Total capacity	litres	3000	3000	4000	4000	4000	4731	5546	7176	8806	10376
Nominal inlet/outlet diameter	mm	110	110	110	110	110	110	110	110	110	150
Overall length	m	2.1	2.1	2.6	2.6	2.6	3.1	3.6	4.6	5.6	6.6
Overall width	m	1.64	1.64	1.64	1.64	1.64	1.64	1.64	1.64	1.64	1.64
Overall height	m	2.24	2.24	2.24	2.24	2.24	2.24	2.27	2.27	2.27	2.27
Inlet invert to base	m	1.375	1.375	1.375	1.375	1.375	1.375	1.375	1.375	1.375	1.35
Outlet invert to base	m	1.3	1.3	1.3	1.3	1.3	1.3	1.3	1.3	1.3	1.3
Inlet invert to ground level	m	0.535	0.535	0.535	0.535	0.535	0.535	0.535	0.535	0.535	0.56
Outlet invert to ground level	m	0.61	0.61	0.61	0.61	0.61	0.61	0.61	0.61	0.61	0.61
Height above ground level	m	0.33	0.33	0.33	0.33	0.33	0.33	0.36	0.36	0.36	0.36
Weight empty**	kg	270	270	300	300	300	370	400	500	600	700
Air-Blower (50Hz)	W	50	50	50	64	64	86	100	215	215	215
De-sludge period (minimum)***	year	1-3	1-3	1-3	1-3	1-3	1-3	1-3	0.5-2	0.5-2	0.4-1
Thickness (minimum)	mm	5	5	5	5	5	5	5	5	5	5
Retention time	hours	83	83	83	78	78	76	74	64	59	55

Tricel Novo		UK36*		UK42*		UK50*	
		Tank A	Tank B	Tank A	Tank B	Tank A	Tank B
<b>Max. Population Equivalent</b>	<b>PE</b>	<b>36</b>		<b>42</b>		<b>50</b>	
Design flow rate (max)	litres/day	5400		6300		7500	
BOD load (max)	kg/day	2.16		2.52		3	
No. of persons		13-36		14-42		16-50	
Primary chamber capacity	litres	4800		5410		6200	
Total capacity	Litres	12410		14350		15960	
Nominal inlet/outlet diameter	mm	150	150	150	150	150	150
Overall length	m	2.6	5.6	3.6	5.6	3.6	6.6
Overall width	m	1.64	1.64	1.64	1.64	1.64	1.64
Overall height	m	1.99	2.27	1.99	2.27	1.99	2.27
Inlet invert to base	m	1.35	1.35	1.35	1.35	1.35	1.35
Outlet invert to base	m	1.3	1.3	1.3	1.3	1.3	1.3
Inlet invert to ground level	m	0.46	0.56	0.46	0.56	0.46	0.56
Outlet Invert to ground level	m	0.51	0.61	0.51	0.61	0.51	0.61
Height above ground level	m	0.18	0.36	0.18	0.36	0.18	0.36
Weight empty**	kg	300	600	400	600	400	700
Air-Blower (50Hz)	W	215 + 86		215 X 2		215 X 2	
De-sludging period (minimum)***	year	0.4-1		0.4-1		0.4-1	
Thickness (minimum)	mm	5	5	5	5	5	5
Retention time	hours	55		55		5 <sup>1</sup>	

\*Tanks may require a stepped foundation, with "Tank B" lower than "Tank A" by 100mm approx.

\*\*Allow 100kgs extra for lifting purposes.

\*\*\* Depending on use.

### 3.2 Tank drawings



The arrow indicates a compartment which it is necessary to empty when de-sludging the plant.

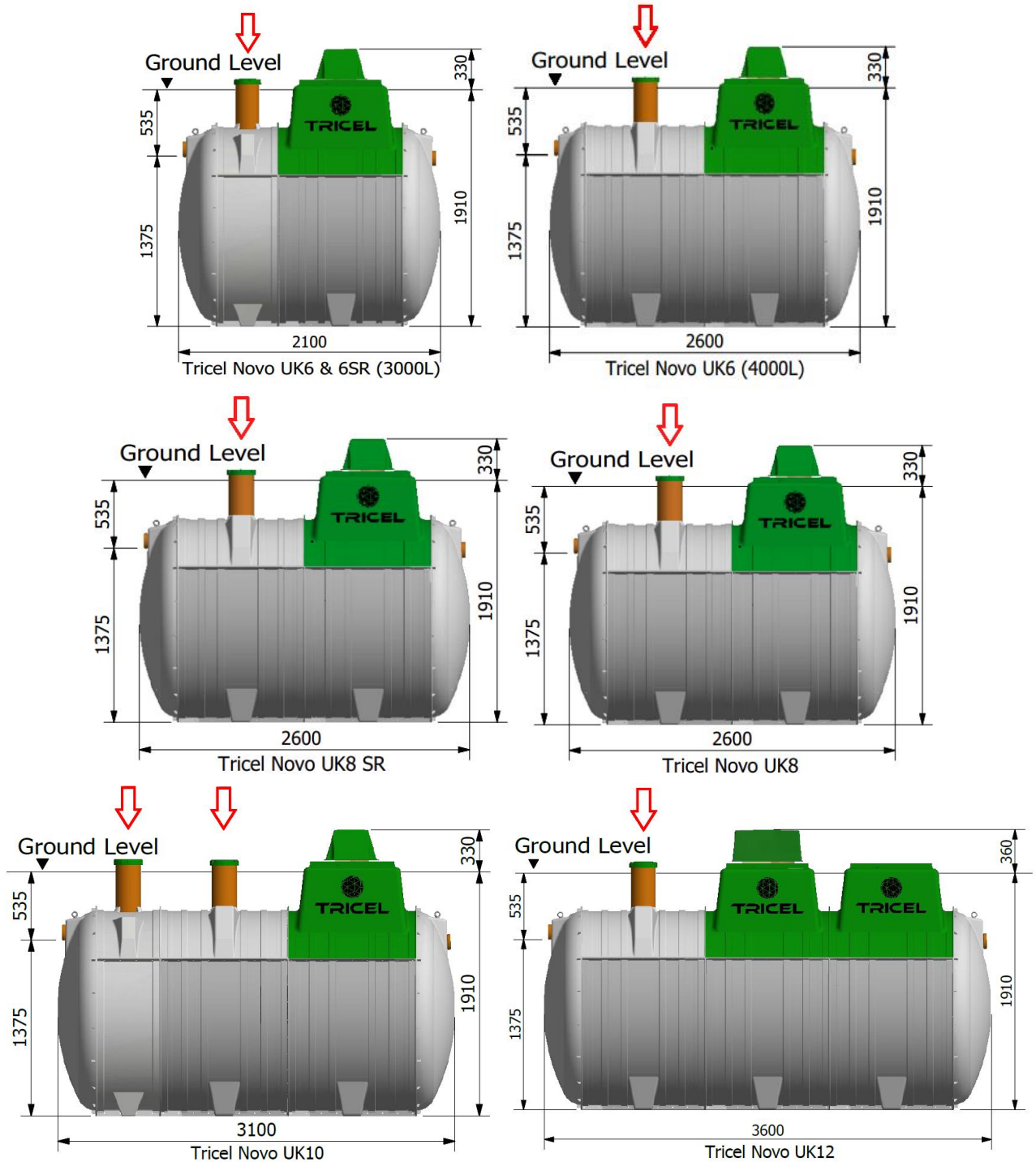



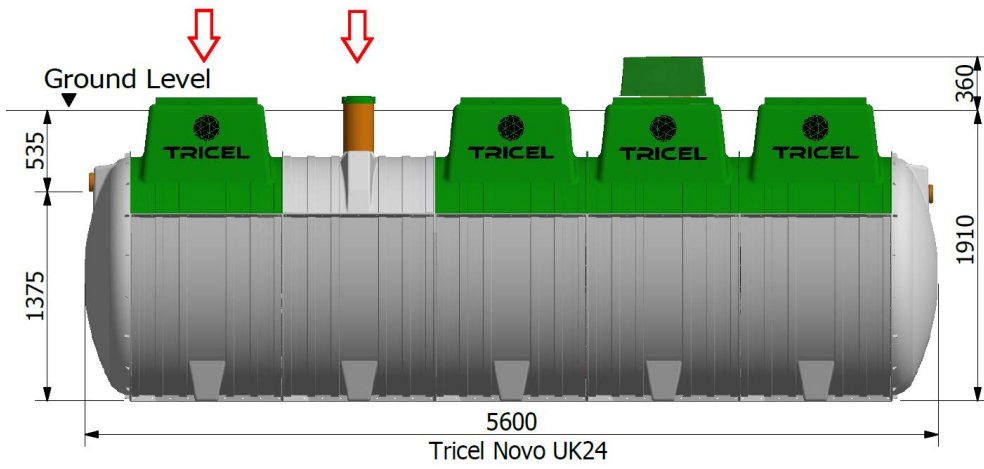
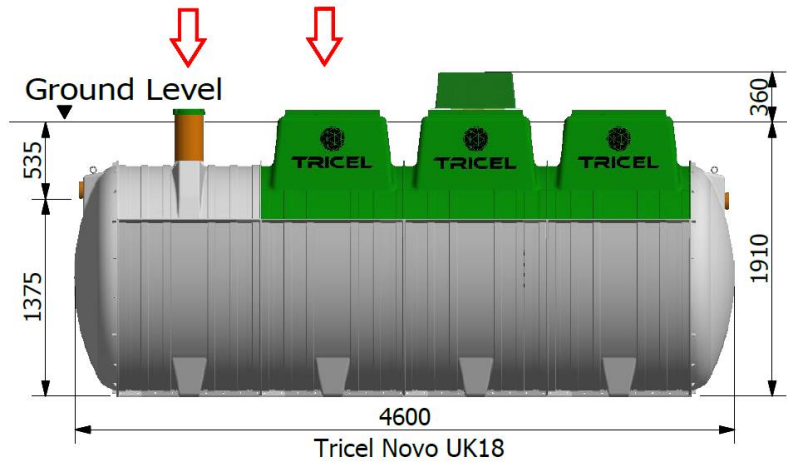

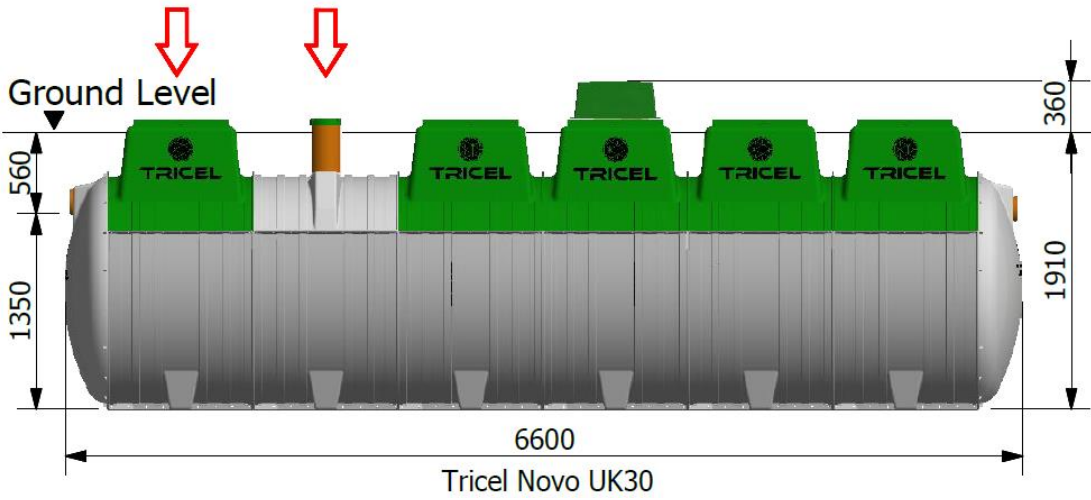

Tricel Novo UK30

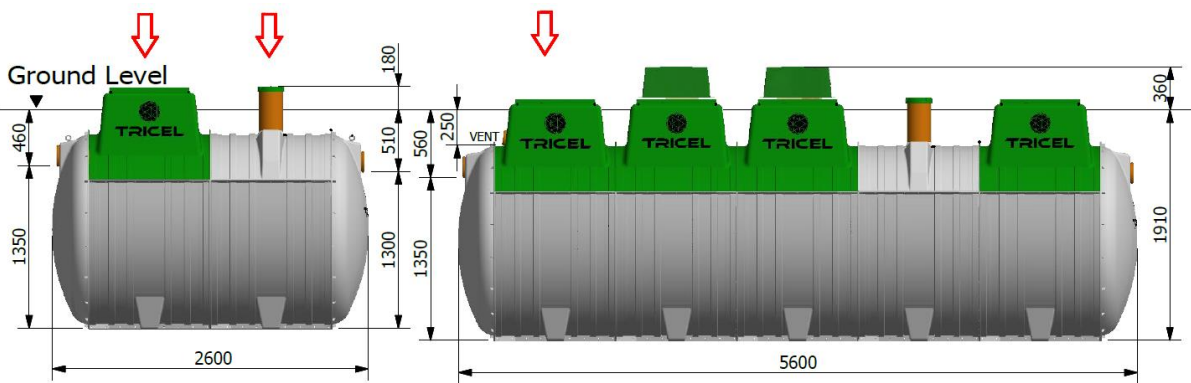

Tricel Novo UK36

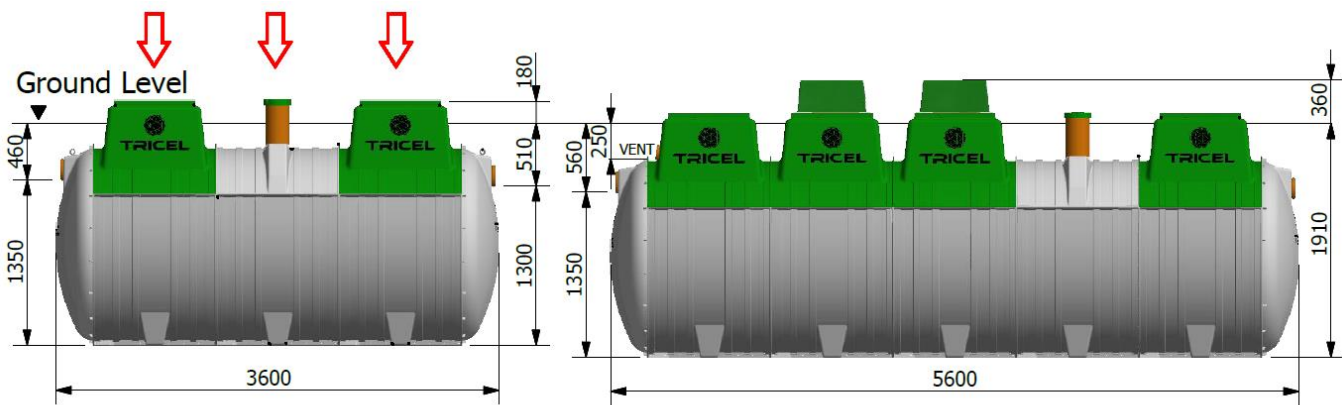

Tricel Novo UK42

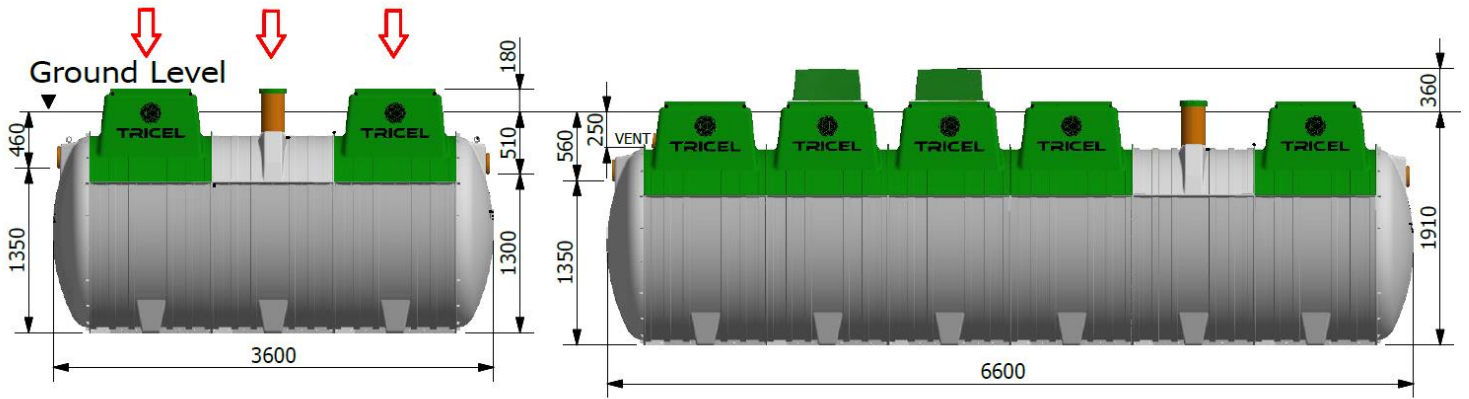

Tricel Novo UK50

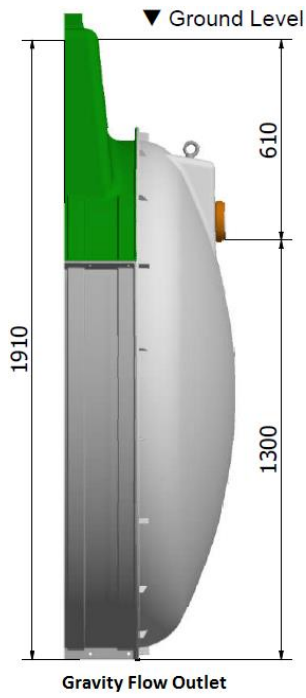

Gravity Flow Outlet

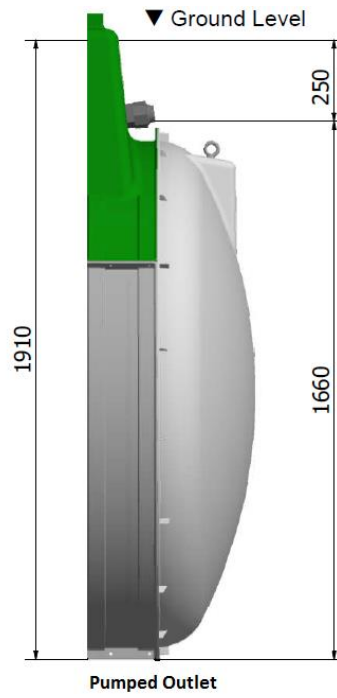

Pumped Outlet

Two-tank Tricel Novo plants require a stepped installation:

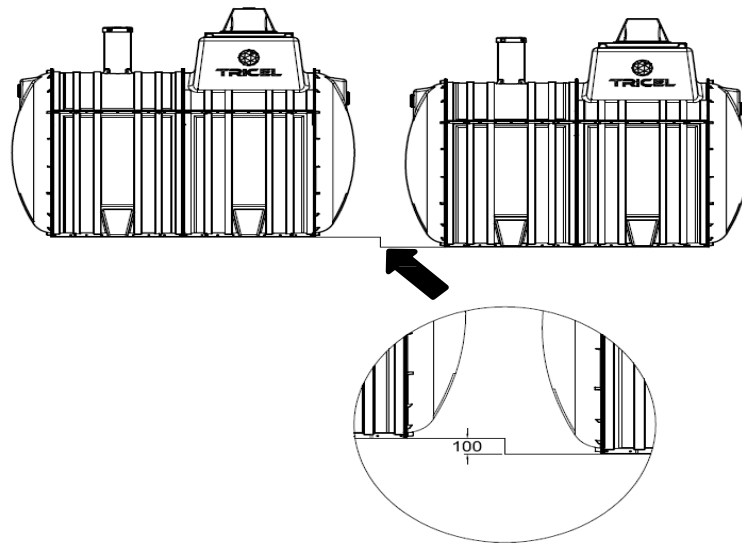

### 3.3 Pumped Outlet

- A pumped outlet option available for all population. The pump is housed in the final settlement chamber of the plant.
- A non-return valve installed on the pumped outlet will prevent backflow into the plant.
- Outlined below is the standard pump specification. Other pump options are available to customer specifications if required; please contact your Tricel Novo supplier.

- Min. discharge rate: 60 l/min
- Continuous duty with 35°C liquids & fully submerged.
- Dry motor (class F insulation).
- IP68 protection.
- Single phase 220-240V 50 Hz 2 poles.
- 0.55kW for single phase.

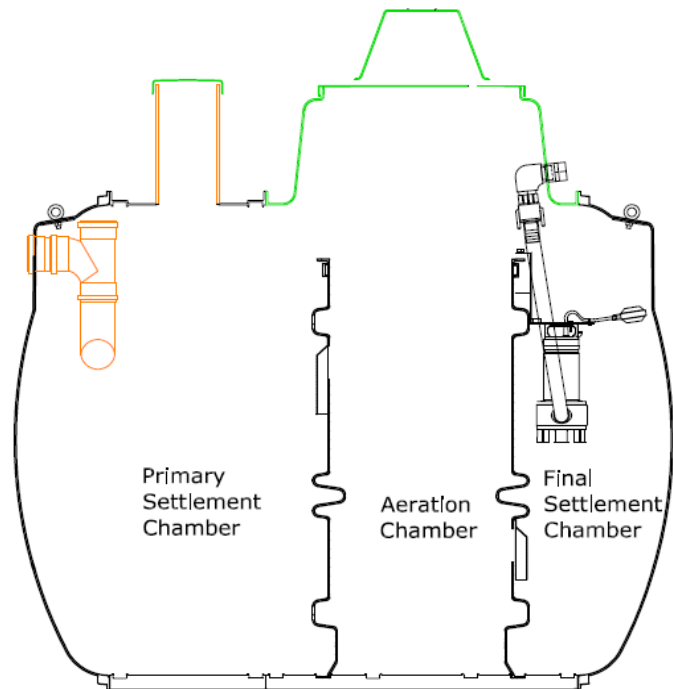

### 3.3.1 Standard pump specification:

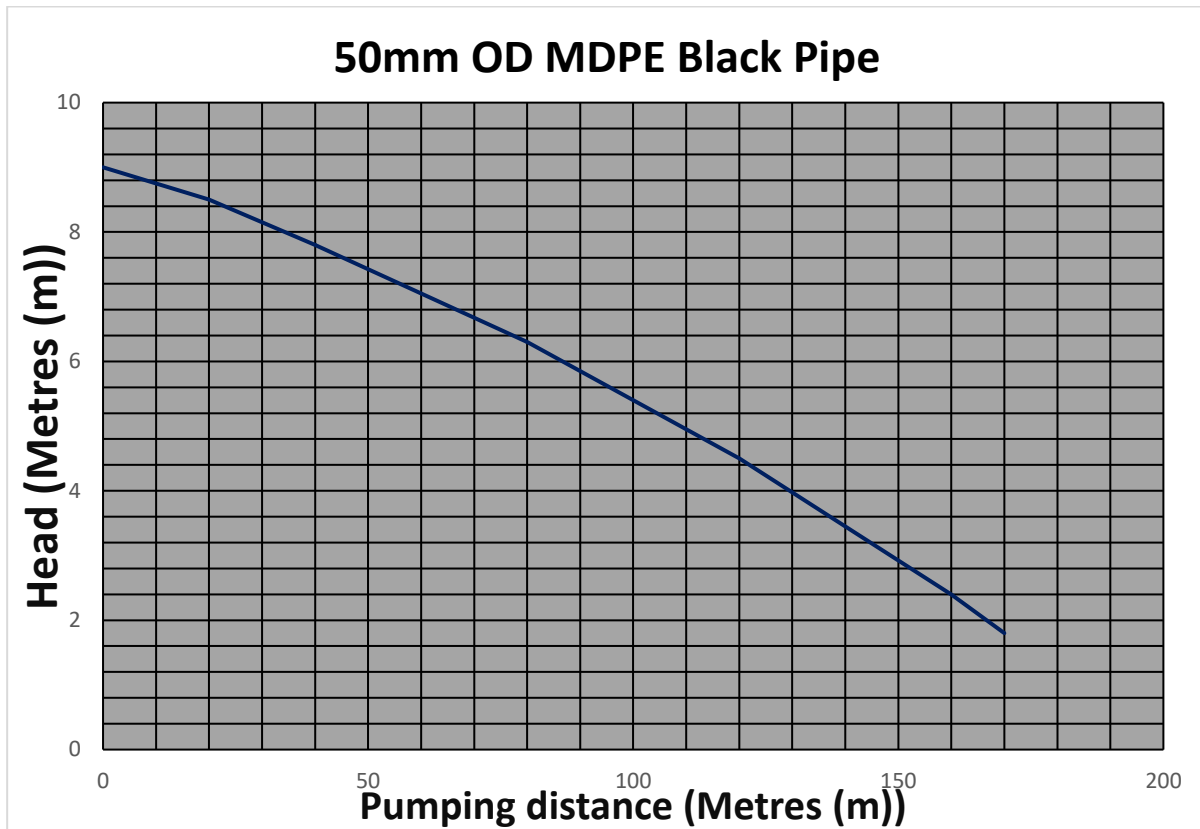

### 3.3.2 Outlet connection:

The Tricel Novo pumped outlet plant has a 50mm end-connector compression fitting which is positioned on the turret of the Tricel Novo. 50mm OD MDPE black piping must be connected to this end-connector compression fitting to transfer the treated wastewater to the discharge point.



## 4 Transportation & lifting

- Tanks must be held down during transportation using nylon straps, do not use cables or chains to secure tanks. Do not over tighten straps that can result in deformation of the tank shell. Do not drop or roll tanks from the truck.
- Move tanks only by lifting and setting, do not drag or roll.



- Always set the tank(s) on flat, smooth ground clear of any debris. Tanks may need to be tied down and chocked to prevent movement. Position the chocks in the locations shown below:

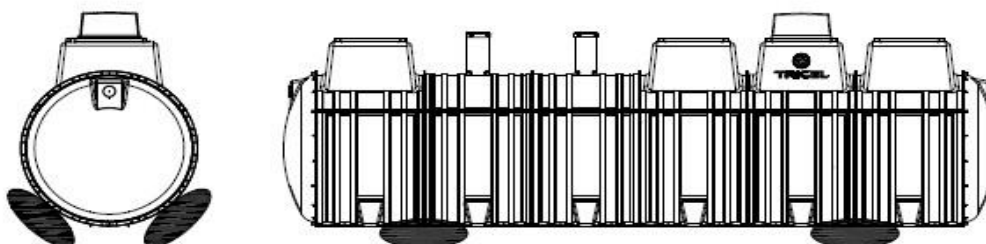

- It is best to lift tanks by a machine and webbing lifting straps – do not use chains or wire ropes in contact with the tank.
- Ensure tank is empty when lifting.
- Care is needed to control the lift so as to ensure the tank is not damaged.
- Ensure the slings are positioned at a joint on the tank, firmly secured, and the load is evenly balanced.

### 4.1 Lifting tanks of 1-4 modules (Max. 4.6m)

- Tanks up to 4.6m in length should be lifted using the eyebolts on the tank.
- Tanks up to 4.6m in length can be lifted using only lifting straps, as shown in *Option 1*, next page. However, on sites where lifting height is restricted, a lifting bar should be used as shown in *Option 2*:

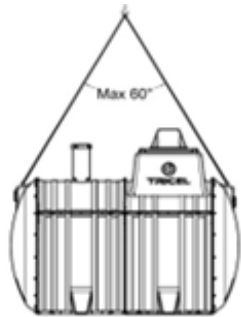

Option 1

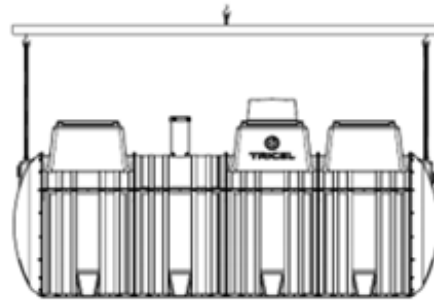

Option 2

## 4.2 Lifting tanks of 5-6 modules (Max. 6.6m)

- Tanks which are greater than four modules (4.6m) in length should be lifted using the slings provided as depicted per *Option 3*, shown below. However, on sites where lifting height is restricted, a lifting bar should be used as shown in *Option 4*:

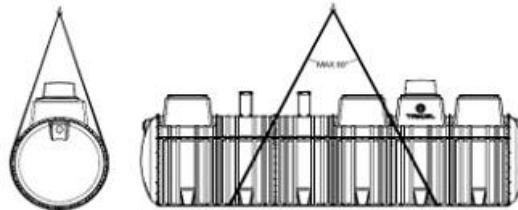

Option 3

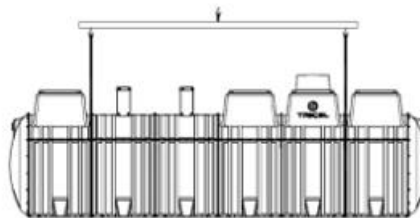

Option 4

**Note:** To ensure the angle of the sling is not greater than 60°, as per *Option 1* above, the following sling lengths are required:

Length of tank	Minimum length of sling
2.1	2.1
2.6	2.6
3.1	3.1
3.6	3.6
4.6	4.6
5.6	5.6
6.6	6.6



# 5 Installation

## 5.1 Installation planning

**Important**

Prior to the installation of the Tricel Novo, it is important to read these installation instructions carefully.

- When planning the installation of a Tricel Novo plant, consider the following:

**Backfill considerations:**

- Is this a dry or wet site, i.e., the presence of a water table?
- Which backfill material is appropriate for this site?
- What are the finished ground level and will risers be required?

**Note: Installations that need 500mm or 750mm risers require a concrete installation. It is not possible to retrofit 500mm & 750mm risers to tanks with gravel installations.**

**Site considerations:**

- Is the site restricted regarding area or height?
  - What is the topography of the site, i.e., being it sloping or flat?
  - What is the proposed depth of the installed tank to ensure the required slope upstream?
  - Are static or rolling loads present on this site?
- Only suitably qualified personnel should install the Tricel Novo.
  - Suitably sized equipment will be required to excavate the hole and to lift the Tricel Novo into place.

## 5.2 Inspection upon reception of tanks

- Visually inspect tanks for damage such as fractures to the shell or ribs, de-laminations, scratches, or abrasions deeper than 1.5mm, which may have occurred during transport, before installation. Notify the delivery driver and your supplier of any damage. Do not attempt to carry out any unauthorized repairs, as this will invalidate the warranty on the tank.
- Once tank installation is complete, Tricel cannot accept any claims for damage.

## 5.3 Positioning and precautions

- Do not undertake the installation of the Tricel Novo in an area subject to flooding or excessive water runoff as no flood waters should enter the tank.
- The area around the Tricel Novo should be adequately drained, to permanently remove ground water and surface water from the proximity of the tank.
- The Tricel Novo is not suitable to be used in waterlogged sites, where the ground water may rise above the inlet invert pipe.
- When selecting the location of the Tricel Novo, ensure that it is always accessible for future maintenance.



## 5.4 Types of installation

All installations must be “fit for purpose” to suit the on-site conditions, which will vary from site to site and is the responsibility of the onsite contractor.

When installing a Tricel Novo, there are two possible installation methods:

1. **Gravel installation**
2. **Concrete installation**

It is necessary to consider two factors when determining which installation must to implement:

### 1. Is the Tricel Novo being installed in a ‘Dry site’ or a ‘Wet site’?

- A **‘Dry site’** is a site in which the water table never rises higher than the base of the tank.
- A **‘Wet site’** is a site in which the water table may rise higher than the base of the tank but will not rise higher than the invert of the inlet. Sites where a higher water level is present, ensure that the installation is suitable for the site conditions.

Tricel strongly advises the installation of a vertical water table inspection pipe. This inspection pipe will facilitate convenient monitoring of the water table long after the completion of the installation process.

**Note:** In difficult soils (e.g., clay with a high t-value), a site could be potentially classified as wet if there is no drainage for surface water that enters the excavation and it rises higher than the base of the tank. The installer must determine this when selecting the correct backfill.

### 2. Is a riser installation required, and if yes, what height riser must you use? (For more information on risers, please refer to section 5.9 ‘Risers’).

The following table specifies the required installation for on-site conditions:

Factors that determine the required installation		Installation required
Type of site	Riser required	
Dry	None	Gravel
Dry	250mm	Gravel
Dry	500mm & 750mm	Concrete
Wet	None	Concrete
Wet	250mm, 500mm & 750mm	Concrete

#### **Important**

- Incorrectly installed tanks that are subject to movement, rotation or floatation may become damaged, for which Tricel cannot accept liability.
- During installation, do not subject tanks to buoyant forces.
- Contact a qualified engineer if there are difficulties on site due to adverse water logging.
- Ballasting the tank is important to avoid the tank from lifting when backfilling.

## 5.5 Installation procedure

### 5.5.1 Excavation (Dry & Wet sites)

**Important**

All excavation works must be done so under the strictest of supervision and in accordance with all associated construction guide lines.

#### 5.5.1.1 Excavation: Length & Width

Length and width of the excavation must exceed the dimensions of the Tricel wastewater treatment plant by a **minimum 500mm** to maintain a **minimum space of 250mm all around the tank**.

**Note:** In gravel installations, it is imperative that the gravel backfill is thoroughly compacted to maximise support for the tank and ensure that there will be no movement in the tank over time.

Tricel Novo	Tank length (m)	Tank width (m)	Min. excavation size (L x W) (m)
6 & 6SR (3000L)	2.1	1.64	2.6 x 2.14
6 (4000L)	2.6	1.64	3.1 x 2.14
8 & 8SR	2.6	1.64	3.1 x 2.14
10	3.1	1.64	3.6 x 2.14
12	3.6	1.64	4.1 x 2.14
18	4.6	1.64	5.1 x 2.14
24	5.6	1.64	6.1 x 2.14
30	6.6	1.64	7.1 x 2.14
36	Tank A	2.6	3.1 x 2.14
	Tank B	5.6	6.1 x 2.14
42	Tank A	3.6	4.1 x 2.14
	Tank B	5.6	6.1 x 2.14
50	Tank A	3.6	4.1 x 2.14
	Tank B	6.6	7.1 x 2.14

**Note:** The size of the area for excavation applies to both dry and wet sites. However, unstable ground with excessive sand, peat swamps, etc., may require larger excavations. The excavation should be maintained dry by pumping or alternative suitable means.

### 5.5.1.2 Excavation: Depth

The depth that the Tricel Novo must be installed is determined by the outlet pipe from the source of the wastewater.

Please refer to section 5.9 'Risers' to determine the maximum invert for the Tricel Novo. Allowances for maximum inverts must be made when the connecting sewer system is being designed by a qualified individual. The Tricel Novo is not suitable where a deeper installation is required.

Outlined below, are the minimum distances (mm) that the excavation dimensions must exceed the tank dimensions for both concrete and gravel installations. Please refer to section 3.1, 'Dimensions' to view all tank dimensions.

Note: Ground instability, e.g. running sand may necessitate over-excavation and stabilization with hard core or blinding concrete.

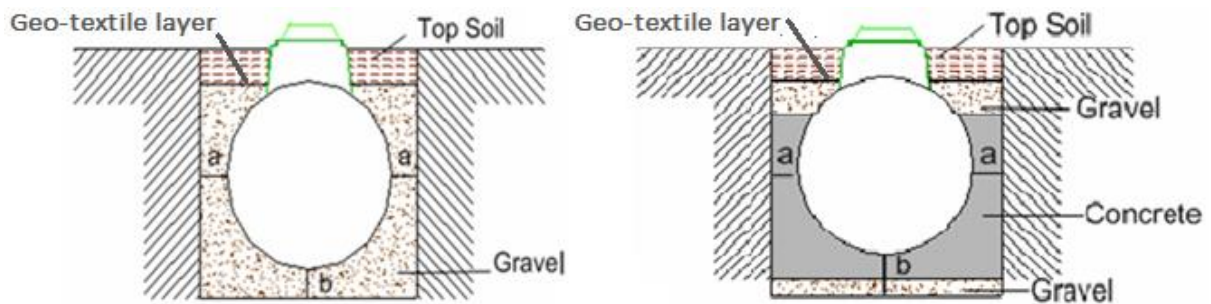

	Tank width (mm)	"a" minimum (mm)	"b" minimum (mm)
Dry Site	1640	250	250
Wet Site	1640	250	300

## 5.5.2 Installation – step by step guide

Steps	Installation required		
	Gravel	Concrete	
Installation of the tank base:	1	Remove any soft spots or large stones and boulders.	
	2	A 250mm layer of suitably compacted gravel forms the base.	A 50mm layer of suitably compacted gravel, covered with a 250mm layer of semi dry concrete forms the base.
	3	Ensure that base is level and at the correct height to accommodate the incoming pipe work.	
	4		It is important to maintain a completely dry excavation until the final pour of concrete becomes set. It may be necessary to line the excavation with a continuous layer of 1200-gauge polythene to maintain the integrity of the concrete.
Positioning the tank onto the base:	5	Mechanically lift the plant carefully into the centre of the hole and place on the prepared base.	Mechanically lift the plant carefully into the centre of the hole before the concrete sets.
	6	The plant must sit level on the base.	
	7	Connect and seal the pipe work to the tank.	
Backfilling around the tank:	8	Ballast the plant by filling each chamber with clean water to a depth of 300mm and recheck the pipe work levels.	
	9	Commence backfilling with gravel in layers of 225mm evenly around the tank ensuring that there are no voids until gravel has reached 50mm over the cylindrical body of the tank. Compact each layer in succession. *	Commence backfilling evenly around the tank, ensuring that there are no voids until it has reached the invert of the outlet pipe. Continue backfilling with gravel, until it has reached 50mm over the cylindrical body of the tank. *
		Note * Continue filling the chambers with water while backfilling, ensure that the progressive water level is no more than 300mm above the backfill level.	
	10	Mount and seal manhole risers (if used). Please refer to section 5.9 'Risers.'	
	11	Complete backfilling with topsoil up to the max ground level. Allow for subsequent settlement of topsoil.	

### **Important**

A competent person should complete the plumbing to, and from, the plant in accordance with national regulations and best practices.

## 5.6 Gravel specification

Primary backfill specification:

- Primary backfill material should be free-flowing granular material.
- Compaction should be by lightweight rollers or vibratory plate. Compact gravel evenly to ensure proper support for the tank. Ensure the vibrating machine does not come in contact with the shell of the tank.
- Install tanks with primary backfill only within the region immediately surrounding the tanks. This primary backfill must extend a minimum of 250mm outward from the tank, and directly beneath the tank.
- Backfill material shall not be frozen or contain lumps of frozen material at any time during installation.
- Use of other than specified backfill and bedding materials will void the tank warranty.

The following approved material is suitable for primary backfill:

### Rounded pea gravel:

- Minimum particle size 3mm, maximum 18 mm, compacted to a relative density of >70%.
- Gravel shall be clean and free flowing, free from large rocks, dirt, sand, roots, organic materials or debris.
- Upon screening analysis, the backfill material shall have no more than 5% by weight passing 2.36 mm sieve.

or

### Crushed or processed stone:

- Minimum particle size 3 mm, maximum 12 mm, compacted to a relative density of >40%
- Dry Gravel density must be at least 1500 kg/m<sup>3</sup>. The material should be washed or screened to remove fine particles.
- Upon screening analysis, the backfill material shall have no more than 5% by weight passing 2.36 mm sieve.

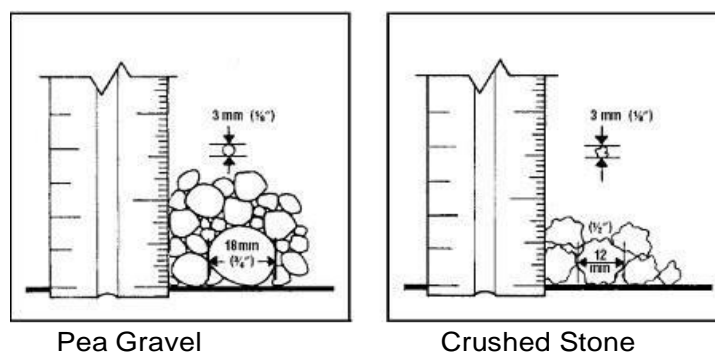

## 5.7 Concrete specification

Semi dry concrete 25n grade with a ratio of 4.5 aggregate to 1 cement.

### **Important:**

- Standard concrete mixes should not be used, where sulphates or similarly aggressive chemicals are present in the groundwater.
- **Lift height (rate of rise):** Determine the lift height (m), or rate of rise (m/h) for the specific type of concrete used to ensure that you do not exceed the design pressure (P max) of 15kN/m<sup>2</sup> on the tank.
- **Vibration:** The tank design assumes minimal compaction of the surrounding concrete. Where necessary, this may be extended to include internal light vibration. Never use deep reverberation which will substantially increase the pressure on the tank, possibly causing failure.
- **Impact of concrete on discharge:** Under no circumstances should concrete be discharged directly onto the tank.

## 5.8 Topsoil requirements

Clean native top soil shall not contain rocks larger than 36mm in the largest dimension.

**Note:** The use of geo textile barrier fabrics surrounding the primary backfill material is considered good installation practice. The fabric must be chosen to allow the flow of water in and out of the excavation but to prevent the movement of fine soil particles into the primary backfill material.

## 5.9 Risers

If a Tricel Novo requires a deeper than standard installation in order to align with the wastewater outlet pipe from the dwelling, manhole risers are available to facilitate this and to avoid the access hatch being positioned in a depression, as shown in the diagram:

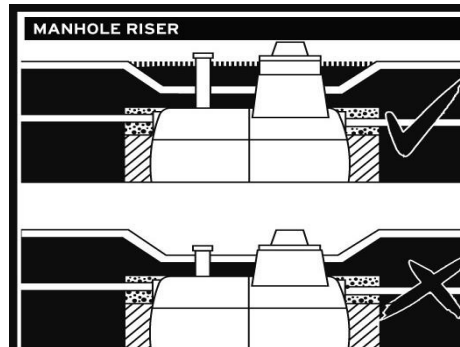

Risers are available in the following sizes:

- **250mm** (requires installation suitable for the site conditions)
- **500mm** (requires a concrete backfill) \*
- **750mm** (requires a concrete backfill) \*

\* 500mm or 750mm risers cannot be retrofitted unless the correct installation is in place.

- The Tricel Novo is suitable for a maximum manhole riser of 750mm which facilitates the following maximum inlet inverts:
  - 110mm Inlet: 1285mm
  - 150mm Inlet: 1310mm
- The Tricel Novo is not suitable where a deeper installation is required.

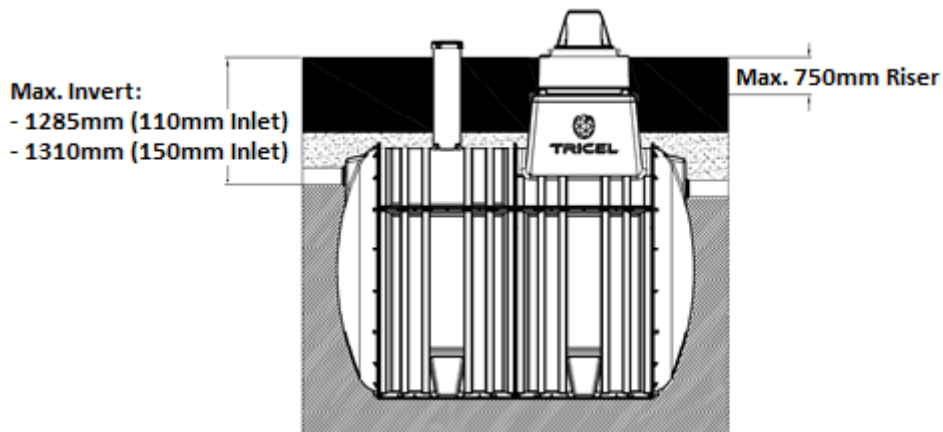

**Important:**

- Never place the access covers below ground level.
- Only use Tricel manhole access covers.
- Do not allow ground water or storm water to enter the Tricel Novo.

## 5.10 Non-standard installations

### 5.10.1 Alternative to concrete backfill (for wet sites without risers only)

- The option of securing the Tricel Novo to a reinforced concrete slab or Deadman anchor by way of straps may also be used, as shown below:



- **Tricel accepts no responsibility for the design of the concrete slab/Deadman anchor.** This solution should be designed by an on-site structural engineer to suit site conditions.
- Position the straps as close to the bolted joints as possible.
- Install the reinforced concrete slab/ Deadman anchor after lowering the level of the ground water, if necessary.
- Once the straps have secured the Tricel Novo, the backfilling with concrete or gravel can commence.

### 5.10.2 Sloping ground

When the slope of the ground is 5% or more, it is recommended to install a retaining wall to protect the tank from the lateral thrust. Concrete backfill may also in some cases be sufficient to protect the tank. A qualified structural engineer must determine if a retaining wall is required in the presence of a steep slope as shown in the picture below:



### 5.10.3 Proximity to rolling & static loads

Minimum separation distances from:

- Rolling Loads (e.g., vehicle traffic): 4 metres
- Static Loads (e.g., dwelling house, shed): 3 metres

If installing the tank in an area where traffic or other superimposed loadings can be applied, consult a structural engineer for the design of a reinforced concrete slab to prevent the transmission of the load to the tank (or its concrete surround). If this slab is constructed immediately above the tank, separate it from the concrete surrounding the tank by a compressible material.



## 5.11 Electrical requirements

**Important:**

- Please ensure the electrical installation complies with all national regulations and requirements.
- Electrical installations must be carried out by a qualified electrician.

The customers' minimum responsibility shall consist in the provision of:

- The power supply SWA cable must be suitably sized and comply with all national regulations and requirements. The sizing of the cable is the responsibility of a qualified electrician.  
**Note:** In typical domestic installations, a single run of 1.5mm<sup>2</sup> three core (two conductors plus earth conductor) steel wire armoured (SWA) cable is required from the customer's distribution cabinet to the tank unit socket box.
- Cable protection via 10-amp MCB protected by(RCD), rated 230V, 30mA.
- The cable armour to the main earth must be properly bonded.
- Never disconnect the power to the air blower. It is imperative that it be running 24 hours a day, every day.
- In the event that a riser is required after the tank is installed, this could be caused by ground levelling works on site, then up to 1m additional power supply SWA cable would be required. Always ensure that electrical work is completed by a competent/ qualified person. This additional length of cable should be coiled and hung underneath the manhole access cover as shown in the following image so that in the event that a riser is installed the power supply will reach the electrical panel on the access cover.



### 5.11.1 Electrical Diagrams

5.11.1.1 For Novo SR, wire the power cable directly to the socket.

#### 5.11.1.2 Tricel Novo – Gravity Outlet

UK6, UK8, UK10, UK12:

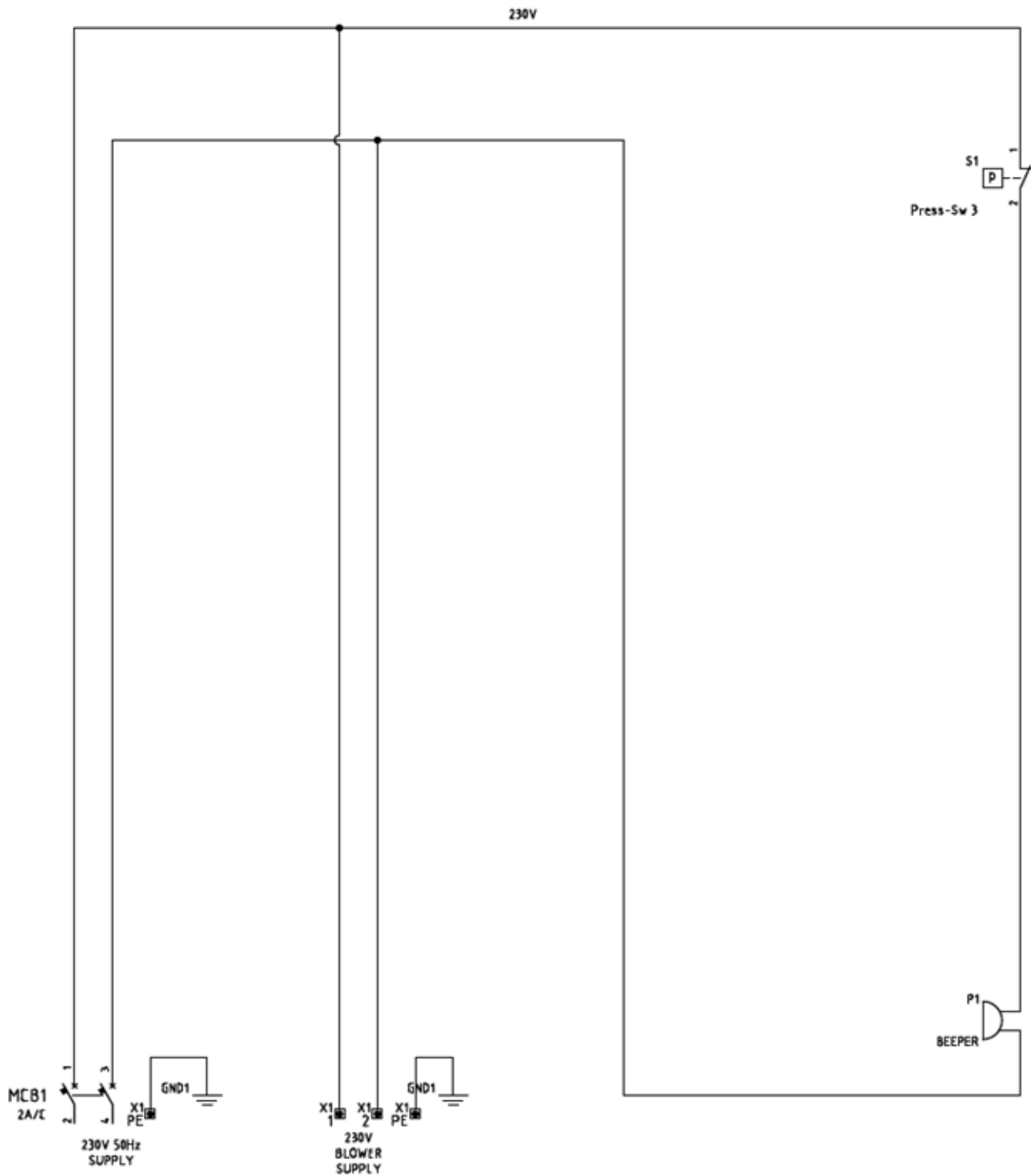

UK18:

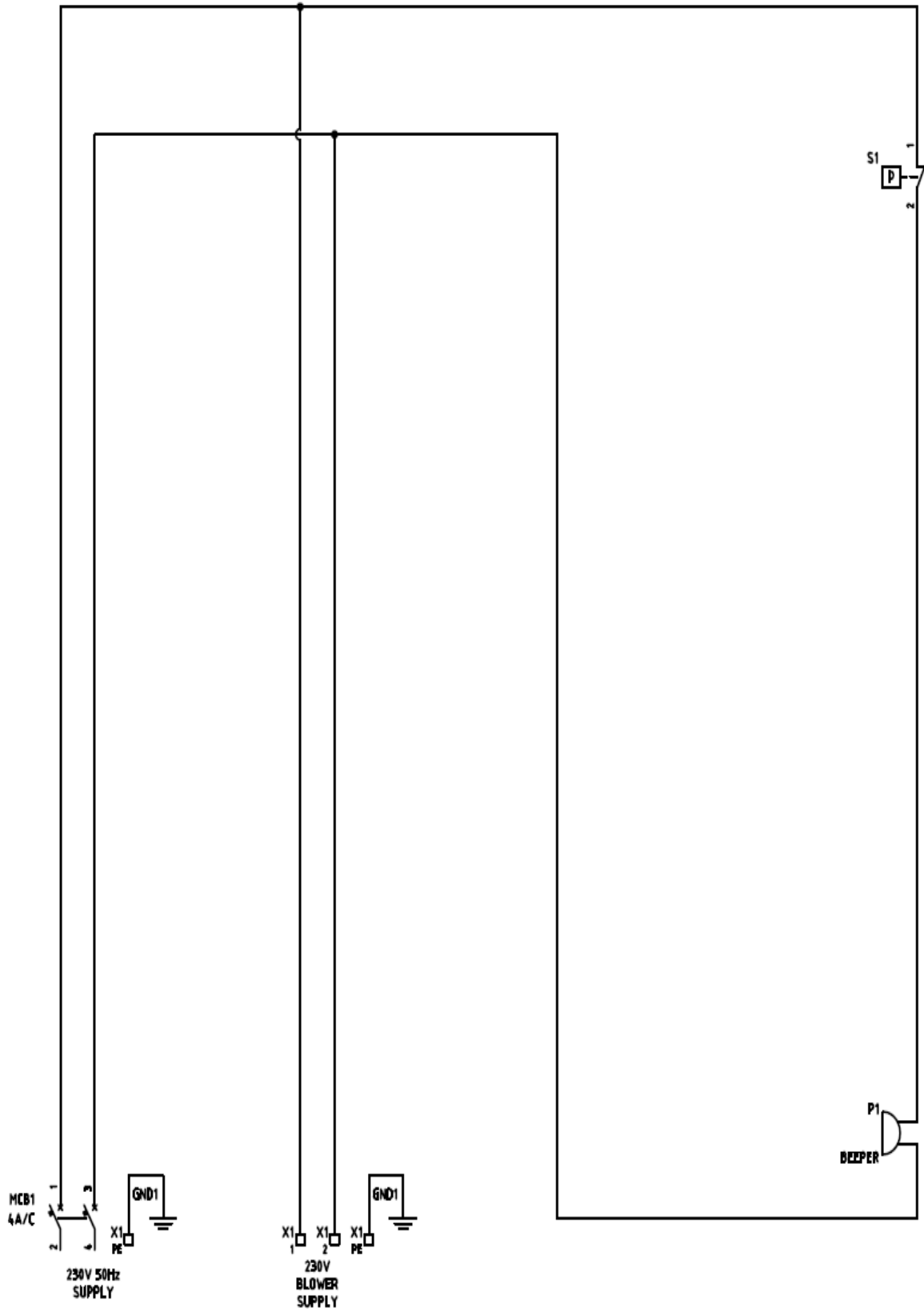

UK24, UK30:

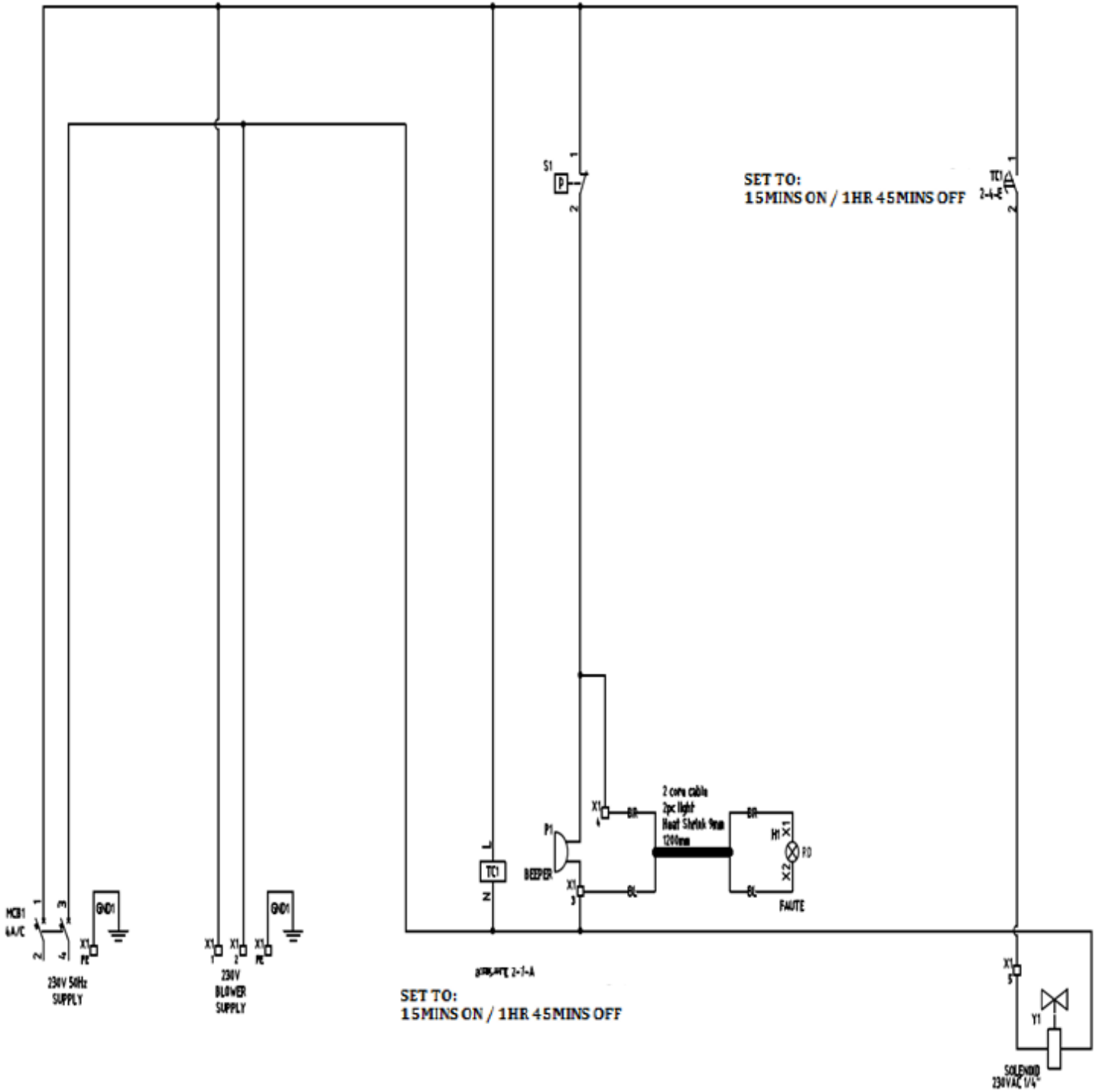

UK36, UK42, UK50:

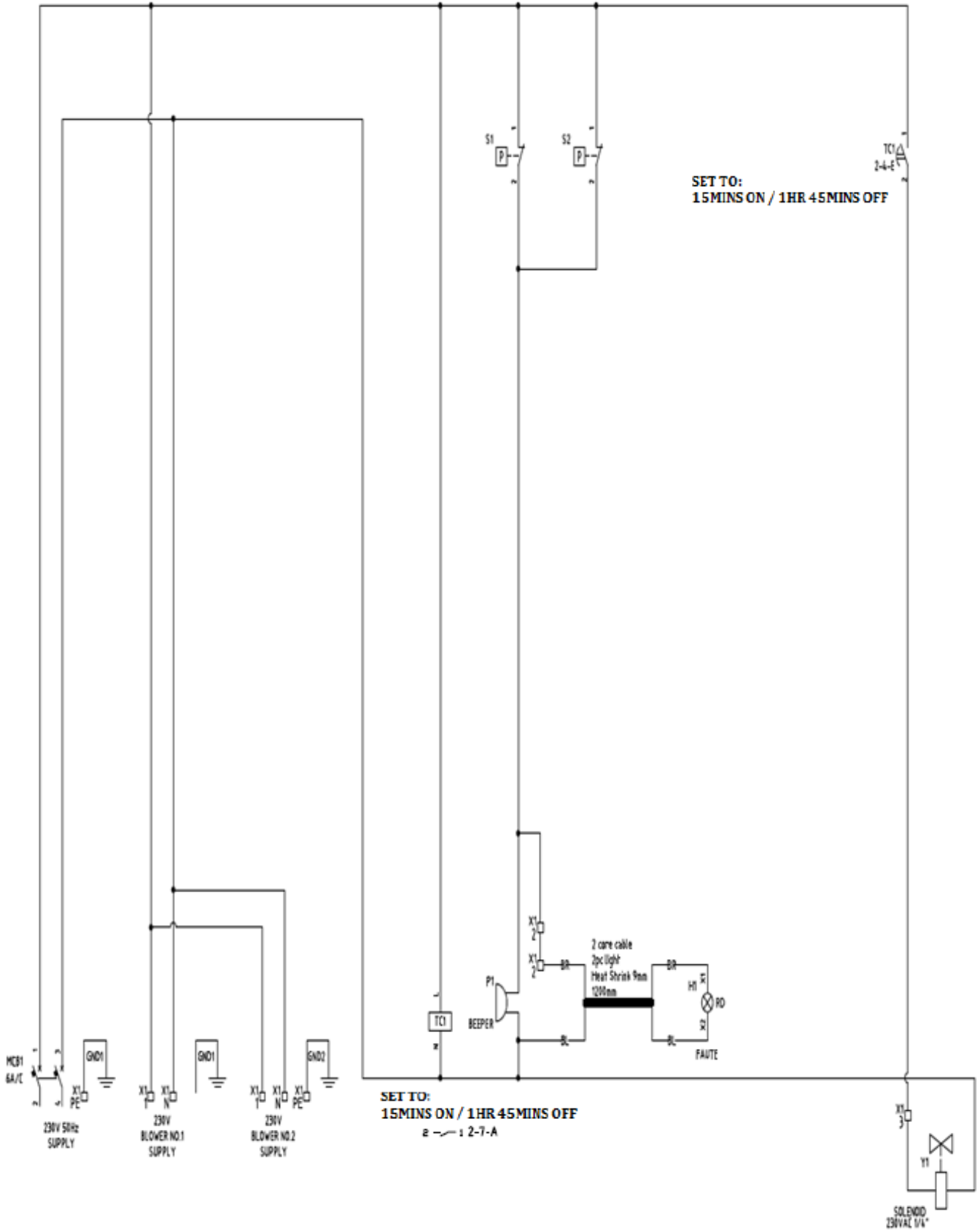

### 5.11.1.3 Tricel Novo – Pumped Outlet

UK6, UK8, UK10, UK12, UK18:

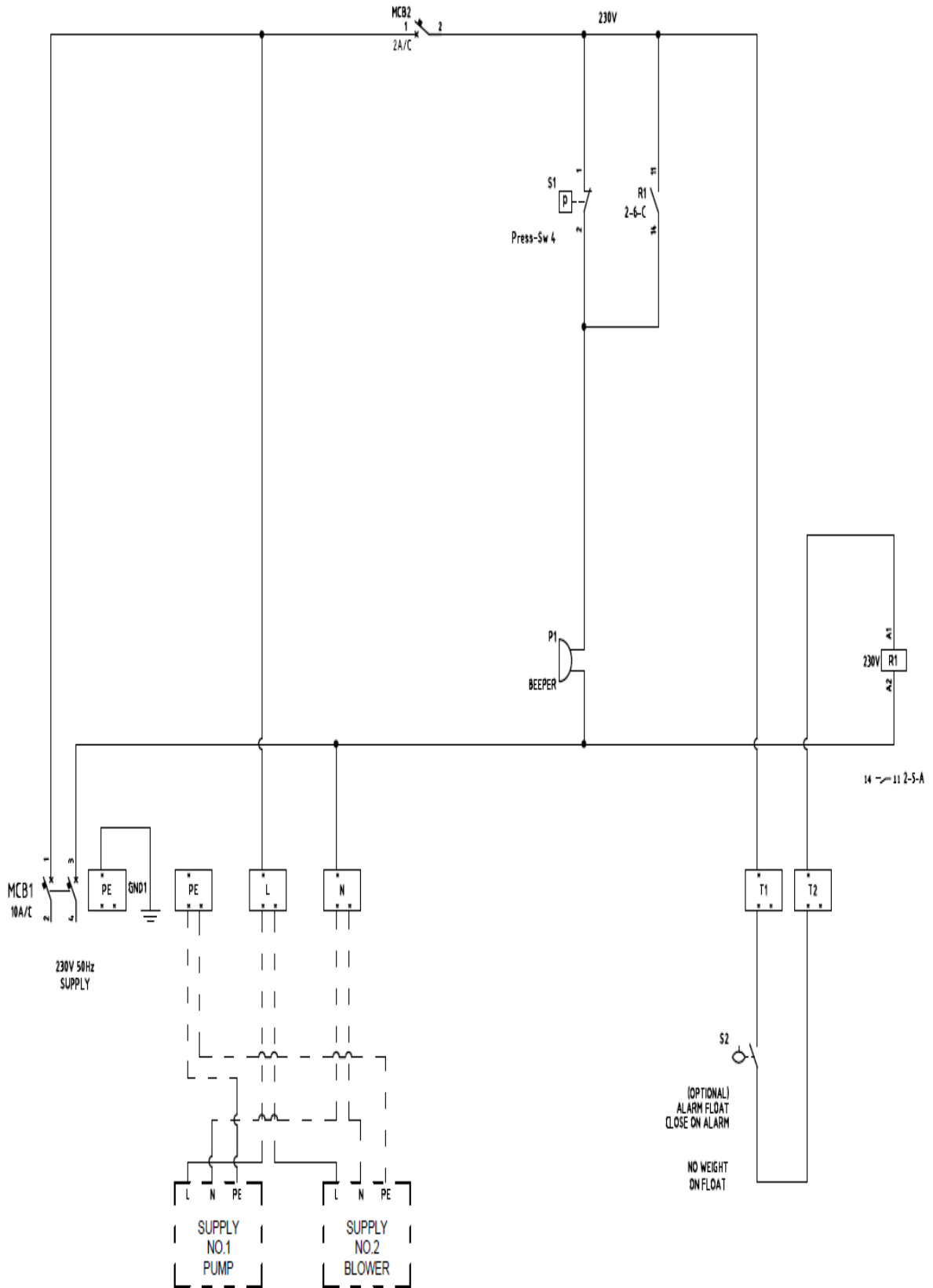

## 5.12 Additional accessories

### 5.12.1 Grease trap

- Fit the grease trap before the Tricel Novo as best practice indicates, particularly in applications where high quantities of grease/oil exist in the wastewater.
- The grease trap must be monitored on a regular basis and emptied when required to ensure continued effective performance.

### 5.12.2 Sampling chamber

- Best practice indicates that a sampling chamber is fitted after every Tricel Novo to allow easy access for sampling purposes.
- Care should be taken to ensure that the sampling apparatus does not come into contact with the pipework or walls of the sampling chamber to avoid contamination of the sample.
- The inlet of the sampling chamber must be higher than the outlet to facilitate the sampling cup.

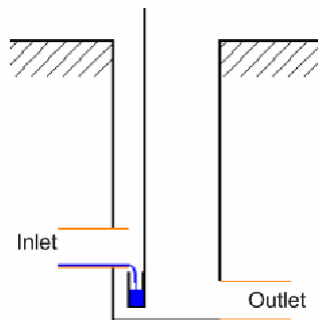

## 6 Plant operation

Once tank installation, plumbing and the electrical connection are complete, the Tricel Novo is now operational. The plant should be filled with water during installation. If you have not, it should be filled before its first use. If the plant is running correctly, you will hear a slight “hum” from the air blower, and there will be air bubbles coming up evenly from the bottom of the aeration chamber, rising to the surface.

The plant runs 24 hours a day, seven days a week all year round for optimum purification. In periods of low occupancy, the sludge return system re-circulates the liquid in the plant ensuring continuous performance. In periods of overload the sludge return plant passes the liquid back into the primary chamber, so it passes through the aeration chamber again ensuring continuous performance. It may take up to 13 weeks for the biomass to become fully established and to reach optimum purification. All non-SR plants come fitted with an alarm, which will alert of irregularities in the plant.

## 6.1 Diffuser-manifold calibration (only applicable on plants UK12 and larger)

Plants come supplied with the manifold valves in the fully open position as shown in the following image.



The valves on the manifold may require adjusting during installation and subsequent services in order to distribute the air evenly among the diffusers.

### Warning

- Each valve must not be closed more than 50% as this will result in irreparable damage to the air-blower.
- Only Tricel approved personnel should make adjustments to the diffuser-manifold.

## 6.2 Timed sludge-return system (only applicable to plants UK24 and larger)

The timed sludge-return system is set to operate for 15 mins followed by a rest period of 1 hour 45 mins.

# 7 Disposal of treated water

Dispose of the treated wastewater from the Tricel Novo as per guidelines from the planning regulations issued by your local authority.



## 8 Maintenance

### **Warning**

Any maintenance carried out inside the tank represents a confined space. Therefore, the maintenance person must be suitably trained to work in confined spaces. Sewage and sewage effluent can carry micro-organisms and gases harmful to human health. Any person carrying out maintenance of the plant must be trained appropriately. Wear suitable protection equipment including gloves, goggles, etc. at all times. Always remove contaminated clothing and protective equipment after completion of work. Wash hands and face before eating, drinking or smoking. Please refer to section 1 'Health & Safety Precautions.'

A certain amount of plant maintenance is required on an on-going basis to ensure that the plant is working correctly, and this is the responsibility of the homeowner.

### 8.1 Regular maintenance

- The vent around the base of the blower housing guarantees a fresh supply of air to the air blower. All vents should be checked to make sure they are not blocked or obscured.
- The vent under the de-sludging cover allows gas to escape and stops the tank from becoming pressurized.
- Ensure the air blower is working by listening for a gentle hum when standing beside the plant.
- The inlet and outlet should be inspected and rodded to remove any blockages if necessary.

### 8.2 Annual maintenance

- The Tricel Novo will require a full service (available from your supplier) every year to guarantee the maintenance of the efficiency of the plant. You must accommodate service personell with clear access to the tank.

### 8.3 Annual service (available from your supplier)

During routine servicing, the service technician will perform a series of checks and procedures:

#### Checks:

- The air-diffuser is monitored to check for sufficient dispersion of air.
- The sludge return system is functioning correctly.
- The covers and locks are in place and good condition.
- General appearance and condition of the treatment plant are good.

## Procedures:

- The blower is tested.
- The blower filter is replaced.
- The plant alarm\* is tested.
- The pump and float-switch are tested (If applicable).
- The vents are cleared of any blockages.
- The sludge level in the primary chamber is measured.
- The diffuser manifold is adjusted if required (If applicable).

## 8.4 Production of sludge

### **Important**

- The de-sludging of the Tricel Novo is the responsibility of the homeowner.
- There is the potential danger of falling into the tank during de-sludging when manholes may be open – take all necessary safety precautions when de-sludging.
- Do not allow machinery/traffic drive over the plant. Maintain a distance of at least 4 metres away from the covers on the Tricel Novo.
- The access cover should never be left off an unattended Tricel Novo.

When the sludge is occupying 50% of the volume of the primary chamber de-sludging is required, this is necessary when the sludge is 700mm deep. For de-sludging periods, which depends on the occupancy of the dwelling, please refer to the table in section 3.1 'Dimensions.' Carry out de-sludging with a vacuum tanker (Tricel recommend the use of a licensed company).

## 8.5 De-sludging (emptying the solid waste from the primary chamber)

- Remove the de-sludging access covers.
- Empty the Tricel Novo using a vacuum tanker. Ensure the removal of the solids with the liquid.
- Care must be taken not to damage the Tricel Novo with the hose of the vacuum tanker.
- After emptying (de-sludging) the primary sludge chamber of any Tricel wastewater treatment tank, the primary chamber should be re-filled with water, until the water level flows into the aeration chamber (second chamber).
- Replace the de-sludging access cover securely.

## 9 Operating conditions

### **Warning**

Tricel shall not be liable for any damage or loss, including consequential loss, caused by the failure of any plumbing equipment or failure caused by the inclusion of prohibited material in the plant.

The manufacturer's installation, operation and maintenance instructions outlined in this manual must be followed at all times to ensure the plant operates as designed. Any variations to these conditions could result in the unit not performing to its full potential, and the discharge may not meet the required standards. The property owner has a legal responsibility to ensure that the plant does not cause pollution, a health hazard or nuisance

- De-sludging is a critical part of the successful operation of the Tricel Novo and is the responsibility of the customer.
- Only competent approved personnel should carry out de-sludging.
- De-sludging must be carried when required as specified, and the plant should be regularly inspected to check the depth of sludge in the primary chamber. If de-sludging is required, carry it out as soon as possible.
- It is necessary to maintain an electrical connection to the plant for it to function correctly, this ensures that the plant has a continuous air supply and where necessary the discharge pump will operate.
- The Tricel Novo is one part of the overall wastewater treatment system, which includes many components (plumbing, ventilation, plant and polishing filter). Each component has to function correctly for the overall system to work which is the responsibility of the homeowner.
- If the plant installation is carried out incorrectly, flooding, overloading, electrical shock or floatation might occur. Tricel is not responsible for incorrectly installed plants.
- Soakaways, drains and the emptying of the primary chamber remains the responsibility of the client. The manufacturer does not cover damage to the installation due to the influx of surface water or the backing up of soak ways or drains.
- To ensure the continuance of the Tricel Novo's performance the user must take certain precautions including the following:
  - Do not exceed the design loading of the plant.
  - High volume discharges such as those from swimming pools and Jacuzzi's must never enter the plant.
  - Surface water must not enter the plant.
  - Do not allow large quantities of chemicals to enter the plant including but not limited to:
    - Water softener
    - Disinfectants
    - Strong acids and alkalis, or photographic chemicals
    - Oil or grease
    - Petrol or diesel
    - Pesticides
  - Do not allow any of the following to enter the Tricel Novo:
    - Large quantities of milk, alcohol or food
    - Large quantities of bleaches or cleaners
    - Baby wipes, cosmetic and cleaning wipes
    - Sanitary towels
    - Tampons
    - Kitchen paper
    - Nappies
    - Medication
- Service personnel must be accommodated with clear access to the plant.
- If others size the plant, Tricel will supply to these specifications. In this case, the responsibility lies with others in relation to the maximum flow/litres per day, the plant capacity and retention times. Similarly, if Tricel size the plant and a greater load is then placed on the plant by the addition of

extra houses, bedrooms, schools, crèches, etc. or by other means, Tricel is not responsible for the plant overloading or the quality of effluent as the retention times may be compromised.

- Should the plant be used intermittently or if extended periods of non-use are expected, it is recommended that the plant remains on and in operation. The contents of the plant should not be allowed to turn septic due to non-use.
- The tank is not suitable for vehicular traffic. Tricel also recommends fencing off the area to prevent livestock herds from accessing the plant. Where possible, unnecessary human traffic around the plant should be avoided.
- The Tricel Novo is only suitable for human faeces. No animal faeces must enter the plant.

# 10 Troubleshooting

Properly installed, operated, and maintained plants will give many years of trouble-free service. All plants fitted with an alarm, which will alert to irregularities in the plant. If a blower or pump stops working in a non-SR plant a buzzer will sound to indicate there is a problem with the plant. The buzzer can be muted until the problem is fixed. Once fixed, the alarm will reset automatically, and the mute switch must be turned off. All electrical work shall be carried out by a certified electrician.

## 10.1 Plant operation

Symptom	Possible causes	Solution
Blower/Pump will not start or run	Fuse blew (if applicable).	Replace with a fuse of suitable size.
	Tripped breaker.	Reset breaker.
	Low line voltage and wet electrics.	An electrician should check the power supply to the plant.
	Defective blower/pump.	Blower/pump must be checked by a qualified person.
	Thermal overload protection triggered by high ambient temperature.	Allow the blower time to cool. The blower will automatically restart when cooled sufficiently.
Blower operates but delivers no air	Low line voltage or wired incorrectly.	An electrician should check the power supply to the plant.
	Filter blocked.	Replace filter.
	Diaphragm damaged/torn (If applicable).	Replace damaged diaphragm.
	Defective blower malfunction.	Air blower must be checked by a qualified person.
Plant fills above working water level	Subsurface disposal plant clogged.	Contact installer to repair sub surface disposal plant/percolation area.
	Storm water flooding.	Redirect storm water drains. Storm water must never enter the plant.
	Discharge hose/pipe blocked.	Find blockage and remove or replace damaged hose/pipe.
Pump operates but delivers no water	Low line voltage or wired incorrectly.	An electrician should check the power supply to the plant.
	Something caught in impellers.	Clean out impellers or replace the pump. Ensure pump is disconnected from the mains before you attempt to unplug it.
	Delivery hose blocked.	Find blockage and remove or replace the damaged hose.
	Other.	The pump must be checked by a qualified person.
Blowers runs intermittently	Thermal overload tripped.	Protect installation from the sun.
		Air supply vent blocked, clean if necessary.
		Filter blocked, replace if necessary.
		Discharge hose blocked or kinked, remove the obstruction.
	Electrical fault.	Get a qualified person to check that the alarm* is installed correctly and the power supply to the plant is correct.

	Diaphragm damaged/torn (If applicable).	Replace damaged diaphragm.
Pump runs intermittently	Thermal overload tripped.	<b>Check for clogged impeller (WARNING: Ensure the pump is plugged out before you attempt to unclog it.)</b> The pump has run dry so add water.
	Float from the pump stuck.	Ensure the float on the pump is set correct and can move freely.
	Damaged float.	The pump must be checked by a qualified person.
	Air return pipe to the alarm* not returning an air signal.	Check that the air pipe is not damaged or bent. Ensure there is air blowing through this pipe. Check that the pipe is inserted into the alarm correctly.
Alarm* is sounding, but the pump and blower are working	Electrical fault.	Get a qualified person to check that the alarm* is installed correctly.
	The electrical panel is wet.	Get a qualified person to check that the alarm* is installed correctly.

\*Alarm is applicable only for non-SR tanks.

**Note:**

Before taking any corrective action, always positively identify the real source of the odour. Check if the odour is coming from another outside source such as a storm drain. All Tricel Novos' vent gases back through soil pipe and out roof vents. Improperly installed roof vents can cause odour problems. Traps in drains prevent odours from entering the home. To function, they must contain water and be sealed correctly.

## 10.2 Odours

Symptom	Possible causes	Solution
Effluent odour directly outside the house or inside the house	Pipe connections to toilets or drains not connected correctly.	Check that the traps / U - bends in the drains are fitted and the joints sealed.
	An air vent on pipework not fitted or fitted incorrectly.	Ensure all effluent pipes are vented correctly, vents are normally fitted to all pipes, and they should be higher than the eave of the roof.
	Pipe work is damaged or blocked or fitted incorrectly.	Inspect pipe work to ensure it is undamaged and clear of obstructions or sagging.
Bad effluent odour directly over the tank	Pipe work to or from the tank is blocked.	Check the level of liquid in the tank. Ensure the pipes are not blocked and are fitted correctly to the tank.
	Chemical kill of bacteria.	Ensure pumps are working properly (If applicable). If the symptom persists for 48 hours or more, remove all liquid and replace with clean water.
	No air delivery - Hydraulic/Organic is overloading the tank vent.	Check blower is functioning properly
Note:	Smoke bombs/pellets, available from a plumber's merchants, can be used to trace the source the odour.	

## 11 Certification

The Tricel Novo has successfully passed stringent European testing and is approved to the new European standard EN 12566-3 Small wastewater treatment plants for up to 50 PT-Part 3: Packaged and/or site assembled domestic wastewater treatment plants. The Tricel Novo was placed through a rigorous 38-week test, by the certified laboratory PIA GmbH-Testing Institute for wastewater technology in Aachen, Germany [www.pia-gmbh.com](http://www.pia-gmbh.com).

The Tricel Novo passed all structural testing (crush test & durability test) carried out by PIA staff. Water tightness tests were performed by PIA at our headquarters on the range of tanks up to 50PE and successfully passed all of the required tests.

## 11.1 Declaration of performance



### - Declaration of Performance

DOP01CPRUK03201414

#### 1. Classification of Product:

Small wastewater treatment plant for up to 50PT – Packaged and/or Site Assembled  
Domestic  
Wastewater Treatment Plant as set out in EN12566 Part3

#### 2. Name of Product:

Tricel Novo UK6 – UK50

#### 3. Product Characteristics

<b>Material</b>	Glass Reinforced Plastic (GRP)
<b>Technology</b>	Submerged Aerated Filter combined with Activated Sludge
<b>Shape</b>	Horizontal Cylinder with domed ends. 620mm x 620mm and Ø200mm Access openings as required.

#### 4. Intended for Use:

To treat domestic wastewater for up to 50 population  
equivalent

#### 5. Name, Address and Contact Information of Manufacturer:

Tricel (Killarney).  
Ballyspillane Ind. Est.  
Killarney,  
Co. Kerry.  
Tel: +353 (0) 64 6632421  
Web: [www.ie.tricel.eu](http://www.ie.tricel.eu)

#### 6. Plant of Assessment of Verification as set out by the CPR, Annex V:

Plant 2+

#### 7. Name, Address and Notified Body Number of Notified Body who carried out Initial Type Testing

Prüfinstitut für Abwassertechnik  
GmbH Hergenrather Weg 30  
D-52074 Aachen  
Germany  
NB 1739



**8. Declared Performance: Treatment Performance**

Essential Characteristic	Performance*	Harmonised Technical Specification
Nominal Organic Daily Load	0.36 kg/d	
Nominal Hydraulic Daily Load	0.90 m <sup>3</sup> /d	
COD	91.6%      52 mg/l	EN12566-3
BOD <sub>5</sub>	95.9%      11mg/l	
SS	95.3%      16 mg/l	
NH <sub>4</sub> **	79.9%      8mg/l	
Electrical Power Consumption	1.1 kWh/d	

\*Performance results obtained at average organic daily load of 0.26kg/d and hydraulic daily load of 0.9m<sup>3</sup>/d

\*\*Determined at temperatures  $\geq 12^{\circ}$

**Material Performance**

Essential Characteristic	Method	Performance	Harmonised Technical Specification
Water Tightness	Vacuum Test	Pass	EN12566-3
Crushing Resistance	Pit Test	Pass (also wet conditions)	
Durability		Pass	
Reaction to Fire		Class E	

**9. The performance of the product identified in point 2 is in conformity with the declared performance in Point 8. This declaration of performance is issued under the sole responsibility of the manufacturer identified in point 4.**



---

Michael Stack  
Managing Director

27/03/2014



Tricel (Killarney)  
 Ballyspillane Ind Est  
 Killarney  
 Co. Kerry  
 Ireland

13

DOP01CPRUK03201414

**EN 12566-3**

Packaged wastewater treatment plants  
 for treatment of domestic wastewater.

- Product: Tricel Novo UK6 – UK50 Range of Wastewater Treatment Plants
- Material: GRP

**Notified Body:** Prüfinstitut für Abwassertechnik GmbH  
 Hergenrather Weg 30  
 52074 Aachen

**Number.:** NB 1739

**Treatment capacity**

<ul style="list-style-type: none"> <li>- Nominal organic daily load: (BOD<sub>5</sub>)</li> <li>- Nominal Hydraulic daily flow (Q<sub>N</sub>)</li> </ul>	As Set Out in  Table CE  for each Model
---	---

**Effectiveness of treatment:**

Treatment efficiency ratios (at tested organic daily load BOD <sub>5</sub> of 0,26 kg/d and daily hydraulic flow of 0.9m <sup>3</sup> /d)	COD: 91,6 % BOD <sub>5</sub> : 95,9 % SS: 95,3 % NH <sub>4</sub> -N: 56,7 %
--	--

**Water tightness: (Vacuum test)**

**Crushing resistance: (Pit test)** Pass (also Wet)

**Durability** Pass

**Fire Resistance** Class E

## 12 Terms & conditions

Subject to our standard terms and conditions, which are available on request.

## Notes

## Notes

## Notes

Tricel Identification Code	This Tricel Novo is a:	Nominal Organic Daily Load (BOD5) (Kg)	Nominal Hydraulic Daily Flow (Litres)
UK6 / 6SR		0.36	900
UK8 / 8SR		0.48	1200
UK 10		0.6	1500
UK 12		0.72	1800
UK 18		1.08	2700
UK 24		1.44	3600
UK 30		1.8	4500
UK 36		2.16	5400
UK 42		2.52	6300
UK 50		3	7500



Tricel Environmental UK, A trading brand of Dewey Waters Ltd.,  
Tricel Weston, Winterstoke Road, Weston-super-Mare, BS24 9AN, United Kingdom  
**Tel:** 44 (0) 1934 422 311 | **Email:** [environment@tricel.co.uk](mailto:environment@tricel.co.uk) | **www.tricel.co.uk**

In accordance with Tricel normal policy product development these specifications are subject to change without notice.